

YAKIMA Q31

CLIPS / PADS

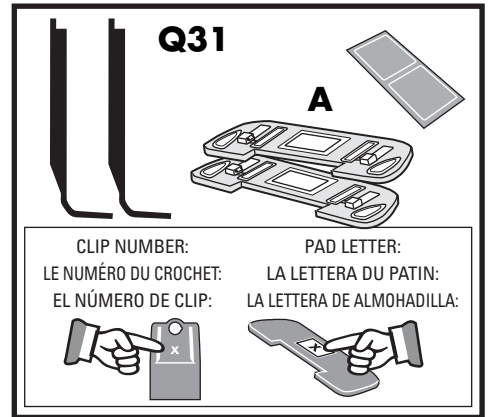
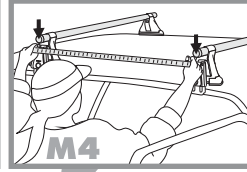
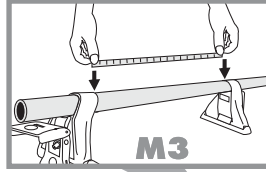
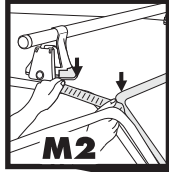
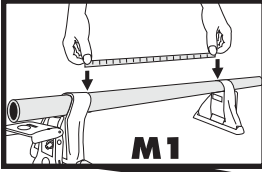

AUDI	M1	M2	M3	M4	
4000	80-87	Q31-A 36-1/8"	3"	Q31-A 36-3/8"	36"
BMW					
3 Series 4dr	99-04	Q30-A 38-1/2"	5"	Q31-A 37-1/2"	32"
7 Series Sedan	79-87	Q30-A 42-1/4"	6"	Q31-A 40-1/4"	36"
BUICK					
Century 2dr	82-94	Q31-A 39-3/4"	4"	Q31-A 39-1/8"	22"
Century 2dr with Q Stretch Kit	82-94	Q31-A 39-3/4"	4"	Q31-A 39-1/8"	36"
Century Wagon	82-93	Q31-A 39-5/8"	5"	Q31-A 39-3/8"	36"
Century Wagon Max Crossbar Spread	82-93	Q31-A 39-5/8"	5"	Q31-A 39"	70"
Electra/Park Ave Sedan	85-90	Q31-A 44"	4"	Q32-A 43-3/4"	36"
Electra/Park Ave Sedan Max Crossbar Spread	85-90	Q31-A 44"	4"	Q32-A 44-3/8"	44"
Le Sabre 4dr	90-91	Q30-A 44-3/8"	4"	Q31-A 43-5/8"	36"
Le Sabre 4dr Max Crossbar Spread	90-91	Q30-A 44-3/8"	4"	Q31-A 43-3/4"	43"
Regal 4dr	79-87	Q31-A 40-3/4"	4"	Q31-A 41-3/8"	36"
Regal 4dr Max Crossbar Spread	79-87	Q31-A 40-3/4"	4"	Q31-A 41-3/4"	43"
Skyhawk 4dr	82-89	Q30-A 38-1/8"	5"	Q31-A 37-3/8"	36"
CHEVROLET					
Caprice/Impala Sedan	79-90	Q31-A 45-3/8"	6"	Q31-A 46-1/4"	36"
Cavalier 4dr	82-94	Q30-A 38-1/8"	5"	Q31-A 37-3/8"	36"
Cavalier Wagon	82-94	Q30-A 38-1/8"	5"	Q31-A 37-3/8"	36"
Cavalier Wagon Max Crossbar Spread	82-94	Q30-A 38-1/8"	5"	Q31-A 36-3/4"	65"
Celebrity Wagon	82-90	Q31-A 39-5/8"	5"	Q31-A 39-3/8"	36"
Celebrity Wagon Max Crossbar Spread	82-90	Q31-A 39-5/8"	5"	Q31-A 39"	70"
Impala Sedan	79-90	Q31-A 45-3/8"	6"	Q31-A 46-1/4"	36"

Look at the notes that apply to your vehicle.

Consultez les notes qui concernent votre véhicule.

Lea la información que se refiere a su vehículo.

YAKIMA Q31

CLIPS / PADS

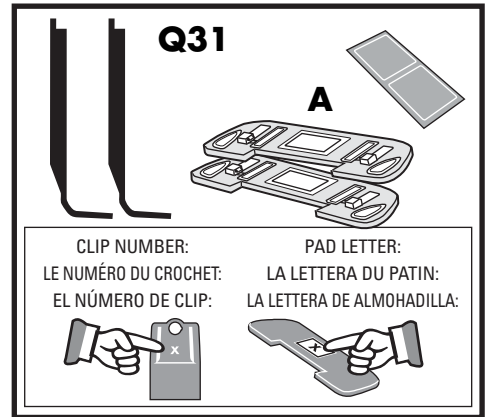
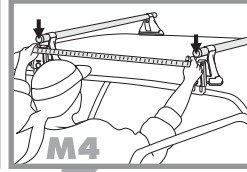
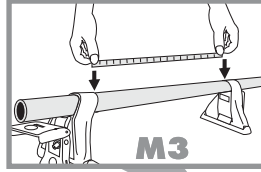
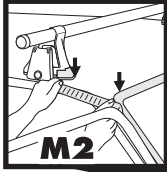
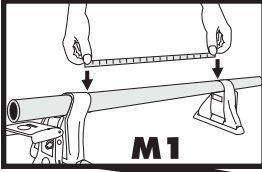

CLIP NUMBER:
LE NUMÉRO DU CROCHET:
EL NÚMERO DE CLIP:

PAD LETTER:
LA LETTERA DU PATIN:
LA LETTERA DE ALMOHADILLA:



Look at the notes that apply to your vehicle.

Consultez les notes qui concernent votre véhicule.

Lea la información que se refiere a su vehículo.

		M1	M2	M3	M4	
CHEVROLET						
Monte Carlo	81-88	Q31-A 43-1/4"	3"	Q32-A 39"	70"	41
Monte Carlo with Q Stretch Kit	81-88	Q31-A 43-1/4"	3"	Q32-A 43-1/8"	36"	36,37
Prizm	98-02	Q31-A 37-1/4"	5"	Q31-A 36-1/2"	30"	
CHRYSLER						
Fifth Avenue	88-89	Q31-A 42"	5"	Q32-A 41-7/8"	32"	37
Le Baron 2dr	82-86	Q30-A 39-5/8"	3"	Q31-A 39-1/4"	24"	102,103,104,112
DODGE						
Challenger	79-83	Q31-A 37-1/8"	1"	Q31-A 37-5/8"	29"	37,102,103,104
Charger Shelby 2dr	82-87	Q31-A 37-1/8"	4"	Q31-A 37-5/8"	24"	102,103,104
Ram 50/D50, Std. Cab	87-93	Q31-A 41-1/4"	4"	Q31-A 41"	18"	101
EAGLE						
Summit 3dr Wagon	92-95	Q30-A 40-1/2"	15"	Q31-A 38-7/8"	33"	41
FORD						
Escort 2dr	81-90	Q30-A 36-3/4"	3"	Q31-A 35-3/4"	36"	
Escort 2dr Max Crossbar Spread	81-90	Q30-A 36-3/4"	3"	Q31-A 35-1/2"	42"	
Escort 4dr	81-90	Q30-A 36-7/8"	5"	Q31-A 35-3/4"	36"	
Escort Wagon	81-90	Q31-A 35-1/2"	3"	Q31-A 35-3/4"	36"	
Escort Wagon Max Crossbar Spread	81-90	Q31-A 35-1/2"	3"	Q31-A 35-5/8"	60"	
EXP with Q Stretch Kit	82-87	Q30-A 38-1/2"	2"	Q31-A 39-1/2"	27"	54,102,103,104
Mustang Coupe	87-93	Q31-A 39-1/4"	3"	Q31-A 38-3/4"	20"	36,54,101,113
Mustang Coupe with Q Stretch Kit	87-93	Q31-A 39-1/4"	3"	Q32-A 37-3/4"	36"	36,113
Mustang Hatchback	87-93	Q31-A 38-7/8"	4"	Q31-A 39"	20"	101,113
Mustang Hatchback with Q Stretch Kit	87-93	Q31-A 38-7/8"	4"	Q31-A 38-3/8"	30"	113
Ranger, Long Cab	86-92	Q31-A 43-3/4"	4"	Q31-A 44-3/4"	30"	

YAKIMA Q31

CLIPS / PADS

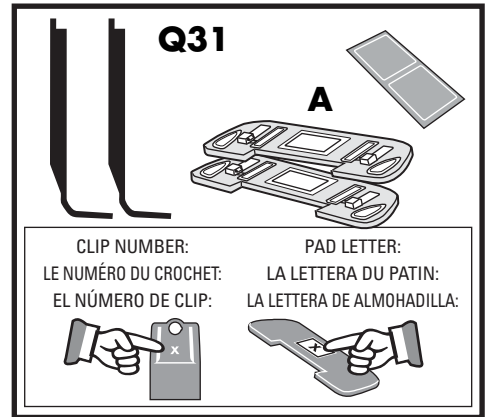
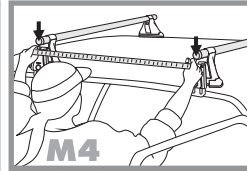
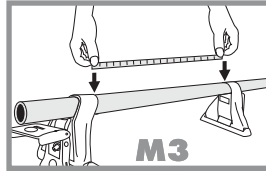
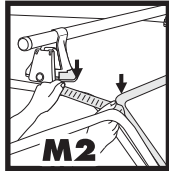
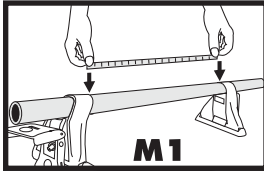

HONDA		M1	M2	M3	M4
Accord 2dr	79-85	Q31-A 35-1/4"	5"	Q32-A 36"	30"
Accord Sedan	79-85	Q31-A 35-1/4"	7"	Q32-A 35-1/8"	32"
INFINITI					
Q45	90-96	Q31-A 42-1/2"	5"	Q32-A 41-3/8"	36"
JAGUAR					
XJ Series Sedan	95-99	Q31-A 42"	6"	Q31-A 42"	36"
XJ Series Sedan Max Crossbar Spread	95-99	Q31-A 42"	6"	Q31-A 42-3/8"	40"
XJ6 Sedan	87-94	Q30-A 43-1/8"	6"	Q31-A 41-3/4"	36"
LEXUS					
IS 300 Sportcross	02-03	Q111-F 37-1/8"	6"	Q31-A 38"	29"
LINCOLN					
Continental	82-87	Q31-A 43-3/4"	5"	Q31-A 45"	36"
MAZDA					
323 2dr	86-89	Q31-A 34"	6"	Q31-A 33-3/8"	32"
626 4dr	88-92	Q31-A 38-1/2"	6"	Q31-A 38-1/8"	32"
MX-6	88-92	Q31-A 38-1/4"	6"	Q31-A 37-3/8"	18"
MX-6 with Q Stretch Kit	88-92	Q31-A 38-1/4"	6"	Q32-A 36-3/8"	30"
MAZDA					
Pickup, Cab Plus	86-93	Q31-A 39-3/4"	4"	Q31-A 39-7/8"	28"
Pickup, Std. Cab	86-93	Q31-A 40-1/2"	3"	Q31-A 40-3/8"	16"
RX-7	93-95	Q31-A 35-3/4"	3"	Q31-A 35-1/2"	16"
MERCEDES					
190 Sedan	84-93	Q31-A 38-1/8"	4"	Q32-A 36-7/8"	30"
C Series Sedan	94-00	Q31-A 39-7/8"	4"	Q32-A 37-3/4"	30"
E300/E320/E420/E500 Sedan	94-95	Q31-A 40-5/8"	4"	Q32-A 39"	32"

Look at the notes that apply to your vehicle.

Consultez les notes qui concernent votre véhicule.

Lea la información que se refiere a su vehículo.

YAKIMA Q31

CLIPS / PADS

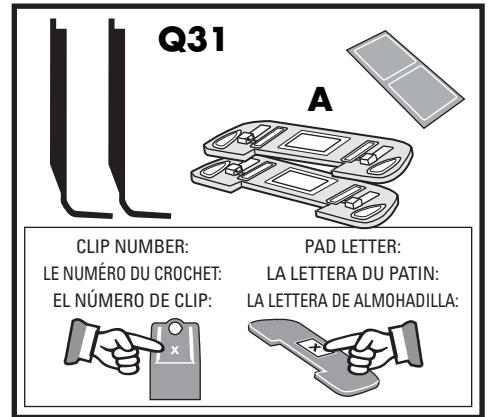
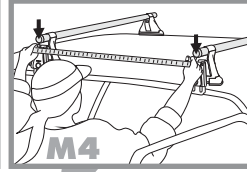
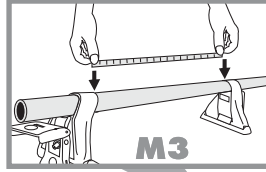
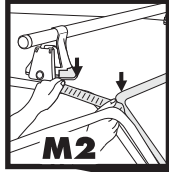
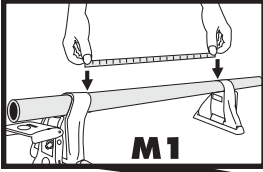

MERCEDES		M1	M2	M3	M4	
E Class Sedan	96-03	Q31-A 40"	6"	Q32-A 39-3/4"	30"	114
S Class Sedan	94-98	Q30-A 44"	6"	Q31-A 43-1/4"	32"	61
MERCURY						
Grand Marquis 2dr	79-85	Q31-A 42-3/4"	4"	Q32-A 42-3/4"	20"	101,114
Lynx 2dr Hatchback	81-87	Q31-A 36-3/4"	3"	Q32-A 35-3/4"	36"	115
Lynx 2dr Hatchback Max Crossbar Spread	81-87	Q31-A 36-3/4"	3"	Q32-A 35-1/2"	42"	115
Lynx 4dr Hatchback	81-87	Q30-A 36-7/8"	5"	Q31-A 35-3/4"	36"	
MERCURY						
Lynx Wagon	81-87	Q31-A 35-1/2"	3"	Q31-A 35-3/4"	36"	40,113
Lynx Wagon Max Crossbar Spread	81-87	Q31-A 35-1/2"	3"	Q31-A 35-5/8"	60"	40,113
Tracer 2dr Hatchback	88-90	Q31-A 34"	7"	Q31-A 33-3/4"	31"	113
MITSUBISHI						
Diamante Wagon	93-94	Q30-A 40-5/8"	4"	Q31-A 38-3/8"	36"	
Expo LRV 3dr Wagon	92-94	Q30-A 40-1/2"	15"	Q31-A 38-7/8"	32"	41,61
Pickup, Std. Cab	87-95	Q31-A 41-1/4"	4"	Q31-A 41"	18"	101
NISSAN/DATSUN						
280 ZX	79-83	Q31-A 37-3/4"	4"	Q31-A 38-1/2"	16"	36,100
280 ZX with Q Stretch Kit	79-83	Q31-A 37-3/4"	4"	Q32-A 38-1/2"	22"	36,101
Sentra 2dr Hatchback	87-88	Q31-A 34-3/4"	4"	Q32-A 34"	18"	101
Sentra 2dr Sedan	82-90	Q30-A 35-5/8"	3"	Q31-A 34-3/4"	34"	
Stanza 4dr Liftback	82-86	Q31-A 35-1/8"	4"	Q32-A 34-3/8"	34"	
Stanza Sedan	90-92	Q30-A 38-1/4"	4"	Q31-A 36-3/4"	30"	61
Stanza Sedan	82-86	Q30-A 36-1/8"	4"	Q31-A 35-1/2"	36"	
Stanza Sedan	87-89	Q31-A 36-3/8"	4"	Q31-A 36-1/8"	32"	

Look at the notes that apply to your vehicle.

Consultez les notes qui concernent votre véhicule.

Lea la información que se refiere a su vehículo.

YAKIMA Q31

CLIPS / PADS

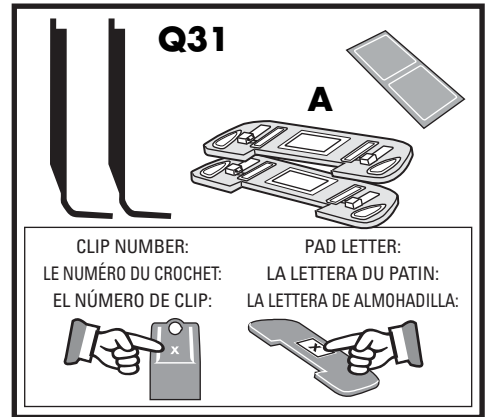
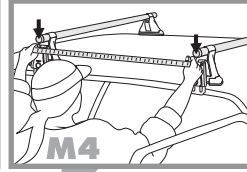
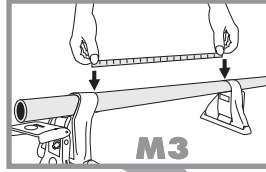
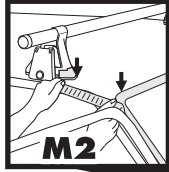
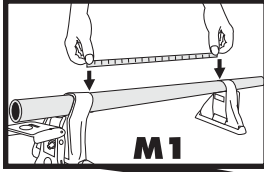

OLDSMOBILE						
98 Regency Sedan	85-90	Q31-A 44"	M2 5"	M3 Q32-A 43-3/4"	M4 36"	37,113
98 Regency Sedan Max Crossbar Spread	85-90	Q31-A 44"	M2 5"	M3 Q32-A 44-3/8"	M4 44"	37,113
Custom Cruiser Wagon	79-90	Q31-A 45-3/8"	M2 3"	M3 Q31-A 46-1/4"	M4 24"	41,102,103,104
Cutlass Ciera 2dr	82-93	Q31-A 39-3/8"	M2 6"	M3 Q31-A 38-7/8"	M4 36"	
Cutlass Ciera 2dr Max Crossbar Spread	82-93	Q31-A 39-3/8"	M2 6"	M3 Q31-A 39-1/8"	M4 43"	
Cutlass Ciera/Cruiser Wagon	82-96	Q30-A 40-3/4"	M2 4"	M3 Q31-A 39"	M4 36"	41,113
Cutlass Ciera/Cruiser Wagon Max Crossbar Spread	82-96	Q30-A 40 5/8"	M2 4"	M3 Q31-A 39"	M4 71"	41,113
Cutlass Supreme 2dr	79-87	Q31-A 43-5/8"	M2 4"	M3 Q31-A 43-7/8"	M4 24"	36,37,102, 103,104
Cutlass Supreme 2dr with Q Stretch Kit	79-87	Q31-A 43-5/8"	M2 4"	M3 Q31-A 43-7/8"	M4 36"	36,37
Cutlass Supreme 4dr	79-88	Q31-A 40-3/4"	M2 4"	M3 Q31-A 41-3/8"	M4 36"	37
Cutlass Supreme 4dr Max Crossbar Spread	79-88	Q31-A 40-3/4"	M2 4"	M3 Q31-A 41-3/4"	M4 43"	37
OLDSMOBILE						
Delta 88/ Regency 98 2dr	79-85	Q31-A 44-1/2"	M2 2"	M3 Q32-A 44-7/8"	M4 28"	102,103,104
Delta 88/ Regency 98 4dr	79-85	Q31-A 45"	M2 4"	M3 Q31-A 46"	M4 36"	
Delta 88/ Regency 98 4dr Max Crossbar Spread	79-85	Q31-A 45"	M2 4"	M3 Q31-A 46"	M4 41"	
Touring Sedan	87-91	Q31-A 43-3/4"	M2 6"	M3 Q32-A 44-3/8"	M4 36"	
PEUGEOT						
505 Sedan	80-90	Q31-A 37-1/2"	M2 5"	M3 Q31-A 38"	M4 36"	113
PLYMOUTH						
Colt Vista Wagon	92-94	Q30-A 40-1/2"	M2 15"	M3 Q31-A 38-7/8"	M4 33"	41
Sapporro	79-83	Q31-A 37-1/8"	M2 1"	M3 Q31-A 37-5/8"	M4 29"	37,102,103,104
Turismo	83-87	Q31-A 37-1/8"	M2 4"	M3 Q31-A 37-5/8"	M4 24"	102,103,104
2000 4dr	82-84	Q30-A 38-1/8"	M2 5"	M3 Q31-A 37-3/8"	M4 36"	
Grand Prix 2dr	79-87	Q31-A 43-3/8"	M2 3"	M3 Q32-A 43"	M4 24"	102,103,104,113

Look at the notes that apply to your vehicle.

Consultez les notes qui concernent votre véhicule.

Lea la información que se refiere a su vehículo.

YAKIMA Q31

CLIPS / PADS

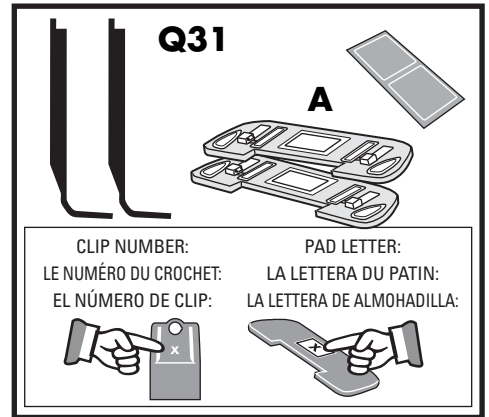
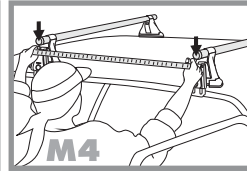
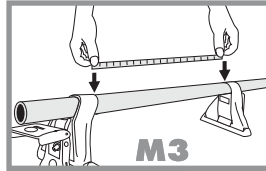
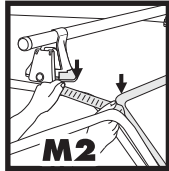
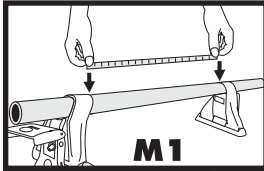

		M1	M2	M3	M4				
PLYMOUTH									
Parisienne Sedan	83-88	Q31-A 44-3/4"	6"	Q31-A 46-1/4"	36"				
Sunbird 4dr	85-94	Q31-A 37-1/4"	6"	Q31-A 37-1/2"	33"				
Sunbird 4dr	82-84	Q30-A 38-1/8"	5"	Q31-A 37-3/8"	36"				
SUBARU									
Wagon	79-84	Q31-A 37"	6"	Q31-A 37-3/8"	36"				
Wagon Max Crossbar Spread	79-84	Q31-A 37"	6"	Q31-A 37-3/8"	52"				
TOYOTA									
Camry Liftback	83-86	Q31-A 39"	4"	Q31-A 39"	36"				
Corolla	03-04	Q99-E 39-5/8"	5"	Q31-A 39-3/4"	32"	114,161			
Corolla FX/FX-16	87-89	Q31-A 36-3/8"	4"	Q31-A 36-1/8"	36"				
Corolla Sedan	98-02	Q31-A 37-1/4"	5"	Q31-A 36-1/2"	30"				
Corolla Sedan	93-97	Q31-A 36-1/8"	5"	Q31-A 35-1/4"	30"	61			
Corolla Sedan	88-92	Q31-A 33-7/8"	5"	Q31-A 33-1/8"	30"	61			
Corolla Sedan	84-87	Q31-A 36-7/8"	4"	Q32-A 35"	36"				
Corolla Sedan	79-83	Q31-A 36-1/2"	4"	Q31-A 36-3/4"	36"				
Cressida Sedan	85-88	Q31-A 37-5/8"	4"	Q31-A 36-3/4"	36"				
Cressida Sedan	79-84	Q31-A 38-3/8"	4"	Q31-A 38-3/8"	36"				
Paseo	96-97	Q31-A 37-3/8"	5"	Q32-A 37"	18"	54,61,101			
Paseo with Q Stretch Kit	96-97	Q31-A 37-3/8"	5"	Q32-A 37"	24"	54,61,102, 103,104			
Paseo	92-95	Q30-A 38-7/8"	5"	Q31-A 38-3/4"	18"	54,61,101			
Paseo with Q Stretch Kit	92-95	Q30-A 38-7/8"	5"	Q31-A 38-3/4"	26"	54,61,102 103,104			
Prius	01-03	Q31-A 40-3/4"	9-1/2"	Q32-A 40-1/8"	28"	102,103 104,114,157			
Supra	86-91	Q31-A 35"	4"	Q31-A 34-5/8"	16"	36,61,63,100			
Supra with Q Stretch Kit	86-91	Q31-A 35"	4"	Q31-A 35-1/8"	28"	36,61,63 102,103,104			

Look at the notes that apply to your vehicle.

Consultez les notes qui concernent votre véhicule.

Lea la información que se refiere a su vehículo.

YAKIMA Q31

CLIPS / PADS

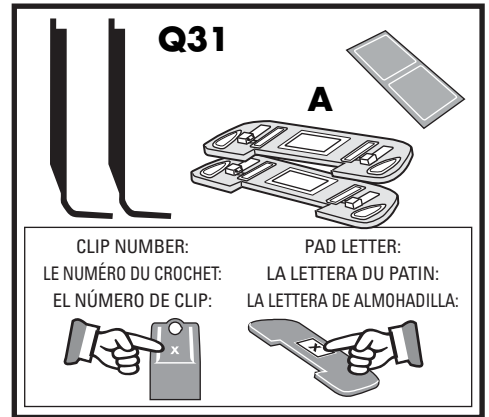
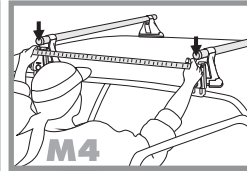
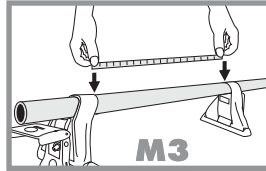
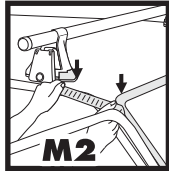
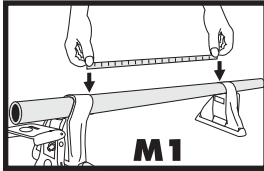

		M1	M2	M3	M4				
TOYOTA									
Tercel 2dr	87-90	Q31-A 35-1/8"	2"	Q31-A 35"	30"				
Tercel, 3dr Liftback	87-90	Q30-A 34-1/4"	4"	Q31-A 32-3/8"	36"	61,113,115			
Tercel, 3dr Liftback	83-86	Q31-A 35-3/8"	4"	Q31-A 34-5/8"	36"	113			
Tercel 4dr	83-86	Q31-A 35-3/8"	4"	Q31-A 34-5/8"	34"	113,115			
VOLKSWAGEN									
Quantum Sedan	82-88	Q31-A 36-1/2"	5"	Q31-A 36-1/8"	36"				
Rabbit/GTI 2dr	79-84	Q31-A 35-3/4"	4"	Q31-A 34-5/8"	36"				
Rabbit/GTI 2dr Max Crossbar Spread	79-84	Q31-A 35-3/4"	4"	Q31-A 34-5/8"	52"				
VOLVO									
240/260 Sedans	79-93	Q31-A 41-3/8"	5"	Q31-A 41-3/4"	36"				
240/260 Sedans Max Crossbar Spread	79-93	Q31-A 41-3/8"	5"	Q31-A 41-3/4"	43"				
740/940/960 Sedans	91-97	Q30-A 43-3/4"	4"	Q31-A 42-7/8"	36"				
740/940/960 Sedans Max Crossbar Spread	91-97	Q30-A 43-3/4"	4"	Q31-A 42-5/8"	45"				
S90	98	Q30-A 43-3/4"	4"	Q31-A 42-3/4"	36"				
S90 Max Crossbar Spread	98	Q30-A 43-3/4"	4"	Q31-A 42-3/4"	45"				

Look at the notes that apply to your vehicle.

Consultez les notes qui concernent votre véhicule.

Lea la información que se refiere a su vehículo.



Look at the notes that apply to your vehicle.
Consultez les notes qui concernent votre véhicule.
Lea la información que se refiere a su vehículo.

36 Yakima racks are not recommended for convertible tops, T-tops or any type of removable roof panels.
Les porte-bagages Yakima ne sont pas recommandés sur les voitures décapotables, les toits en T ou tous les types de toit à panneaux amovibles.
Los bastidores Yakima no se recomiendan para techos convertibles, techos en "T" o techos con paneles removibles.

37 Do not install racks on vinyl covered portions of roof.
Ne pas monter le porte-bagages sur les parties du toit recouvertes de vinyle.
No monte el bastidor en las partes del techo cubiertas con vinilo.

40 The factory luggage carrier may interfere with the Yakima rack.
La présence d'un porte-bagages d'origine peut gêner l'installation du porte-bagages Yakima.
El portaequipajes de fábrica puede interferir con la instalación del bastidor Yakima.

41 The factory luggage carrier may interfere with some accessories.
La présence d'un porte-bagages d'origine peut gêner le montage de certains accessoires.
El portaequipaje de fábrica puede interferir con algunos accesorios.

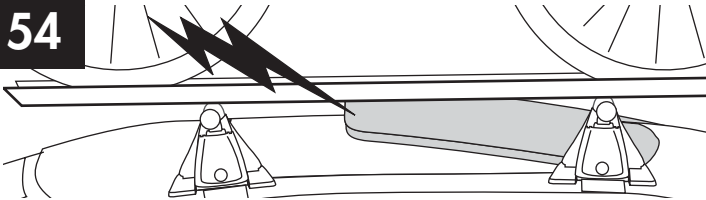

54 When open, the sunroof may interfere with some accessories.
S'il est ouvert, le panneau de toit risque d'entrer en contact avec les accessoires.
El techo corredizo abierto puede interferir con los accesorios.

61 The rubber door seals and/or trim may deform or be damaged under prolonged contact with any roof rack towers and/or clips. Remove rack when not in use.
À la longue, les joints et garnitures de portières peuvent se déformer ou s'endommager au contact de tout crochet ou pied de porte-bagages. Démontez le porte-bagages quand il ne sert pas.
Las guarniciones y rebordes de caucho de las puertas pueden deformarse o dañarse por el contacto prolongado con los soportes de bastidor o clips. Quite el portaequipaje cuando no lo utilice.

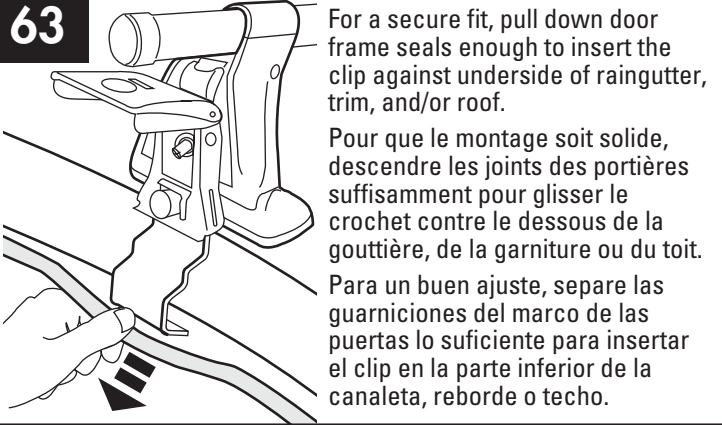

63 For a secure fit, pull down door frame seals enough to insert the clip against underside of rain gutter, trim, and/or roof.
Pour que le montage soit solide, descendre les joints des portières suffisamment pour glisser le crochet contre le dessous de la gouttière, de la garniture ou du toit.
Para un buen ajuste, separe las guarniciones del marco de las puertas lo suficiente para insertar el clip en la parte inferior de la canaleta, reborde o techo.

100 Up to two bicycles may be carried on this vehicle.
Il est possible de transporter deux bicyclettes au maximum sur ce véhicule.
En este vehículo pueden llevarse hasta dos bicicletas.

101 Surf/sailboard length is limited to 8' or less on this vehicle.

Pour être transportées sur ce véhicule, les planches de surf ou les planches à voile ne doivent pas mesurer plus de 2,40 m (8 pieds).

El largo máximo de la tabla de surf o de vela es de 2,40m (8') en este vehículo.

102 Surf/sailboard length is limited to 10' or less on this vehicle.

Pour être transportées sur ce véhicule, les planches de surf ou les planches à voile ne doivent pas mesurer plus de 3 m (10 pieds).

El largo máximo de la tabla de surf o de vela es de 3m (10') en este vehículo.

103 Kayaks must be carried with HullyRollers, LandShark, Mako Saddles, or HullRaisers on this vehicle.

Sur ce véhicule, les kayaks doivent être transportés à l'aide de rouleaux HullyRollers, LandShark, Mako Saddles, ou de berceaux HullRaisers.

En este vehículo los kayaks deben transportarse con HullyRollers, LandShark, Mako Saddles (sillas), o HullRaisers.



Look at the notes that apply to your vehicle.
Consultez les notes qui concernent votre véhicule.
Lea la información que se refiere a su vehículo.

- 104** Canoes must be 14' or less on this vehicle.
Pour être transporté sur ce véhicule, un canot ne doit pas mesurer plus de 4,20 m (14 pieds).
El largo máximo de las canoas es de 4,20m (14') en este vehículo.

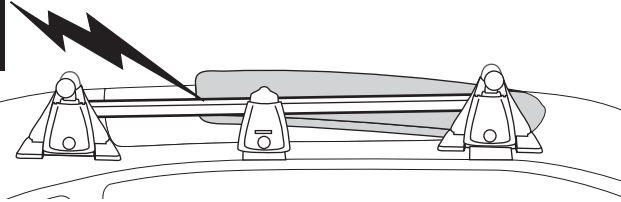
- 112** 
- The sunroof should not be opened while the rack is installed. Remove rack when not in use.
Ne pas ouvrir le toit ouvrant quand le porte-bagages est en place. Enlever le porte-bagages quand il ne sert pas.
No abra el techo corredizo cuando esté instalada la parrilla. Quite la parrilla cuando no la use.

- 113** The roof and/or trim is very soft. Do not overtighten or overload the rack.
Le toit et/ou la garniture est très souple. Ne pas trop serrer le porte-bagages et ne pas le surcharger.
El techo y el reborde son muy blandos. No ajuste demasiado ni sobrecargue el portaequipaje.

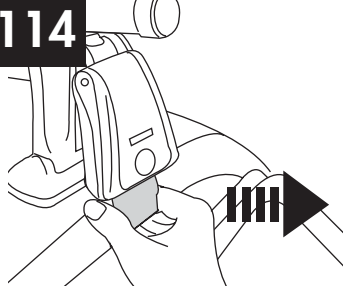
- 114** 
- Caution! Check clips after installing. Grab each clip and try to pull them away from your vehicle. Pull hard! If the clip moves tighten the adjustment post. If the clip still moves, recheck your measurements between the towers and adjust if necessary. Check clip again.
- Attention! Après le montage, vérifier les crochets. Tirer sur chaque crochet pour essayer de l'éloigner de la voiture. Tirer fort! Si le crochet bouge, serrer la vis de réglage. S'il bouge encore, vérifier la distance entre les pieds et la corriger au besoin. Vérifier le crochet de nouveau.
- ¡Atención! Verifique los clips después de instalados. Agarre cada clip y trate de apartarlo del vehículo. ¡Tire fuerte! Si el clip se mueve apriete el poste de ajuste. Si todavía se mueve, vuelva a medir entre los soportes y ajuste si es necesario. Verifique nuevamente el clip.

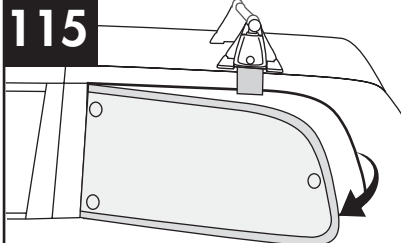
- 115** 
- Install rear clips with rear windows opened.
Pour poser les crochets arrière, ouvrir les glaces arrière.
Instale los clips traseros con las ventanas traseras abiertas.

- 157** Place clips into depressions in door frames.
Placer les crochets dans les creux ménagés dans le cadre des portières.
Coloque los clips en las muescas de los marcos de las puertas.

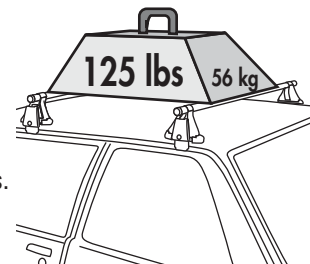
- 161** 
- Do not exceed maximum weight of 125 lbs./56 kg.
Ne pas dépasser la limite de charge maximale de 56 kg/125 lbs.
No exceda el límite de peso máximo de 125 lbs./56 kg.